

2.4G Antenna

MODEL: TH-240S



1. GENERAL DESCRIPTION

Model No
TH240S-SMA(M)

Below is a table summarizing the antenna design specification.

1.1 Electrical Properties

Parameter	Description
Frequency Band	2.4 GHz
Nominal Impedance	50 ohm
Polarization	Vertical
Return Loss	Please See Data-1
V.S.W.R	2.0 : 1
Note: Gain includes the cable loss	

1.2 Mechanical Properties

Parameter	Description
Antenna Type	External Antenna
Antenna Material	PU
Touch Type	Screw Type
Connector Type	SMA 180°(Male)

Antenna Dimensions	28.4mm ±2
Antenna Color	Black
Operating Temperature Range	-20°C~+60°C
Storage Temperature Range	-30°C~+70°C

2. Appearance

NO.	NAME	FINISH	Q, TY
01	Core tube	Black	01
02	SNA 180°(Male)	Nickel plating	01

 Third angle projection	CUSTOMER'S	MODEL	PARTS NUMBER	FREQUENCY	UNIT	SCALE	DATE	VERSION
				2.4GHz	M/M		20100819	1
	TOLERANCE	X. XX±0.15	NAME	PARTS NUMBER	APPROVED	CHECKED	DRAWING	DESIGNED
	SURFACE ROUGHNESS	$\frac{S}{\sqrt{V}}$	APPEARANCE					

3. Frequency

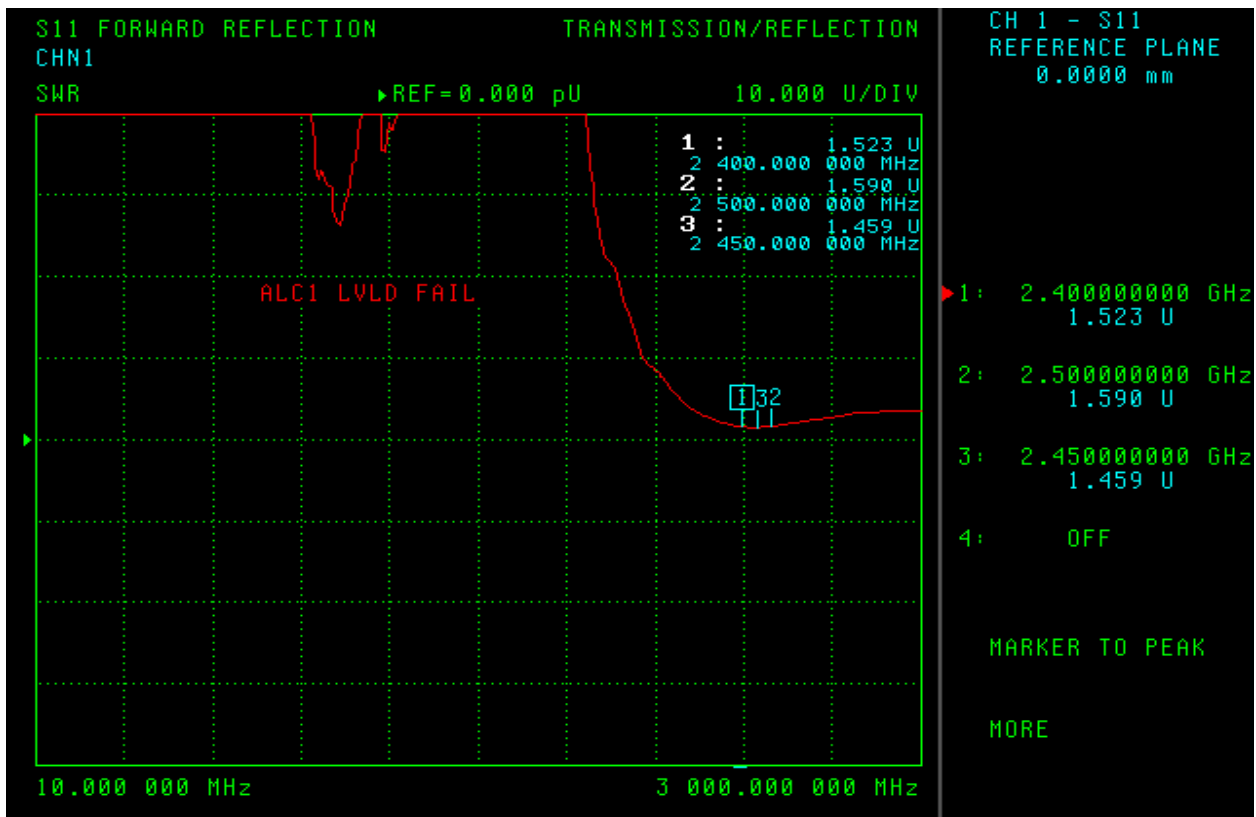
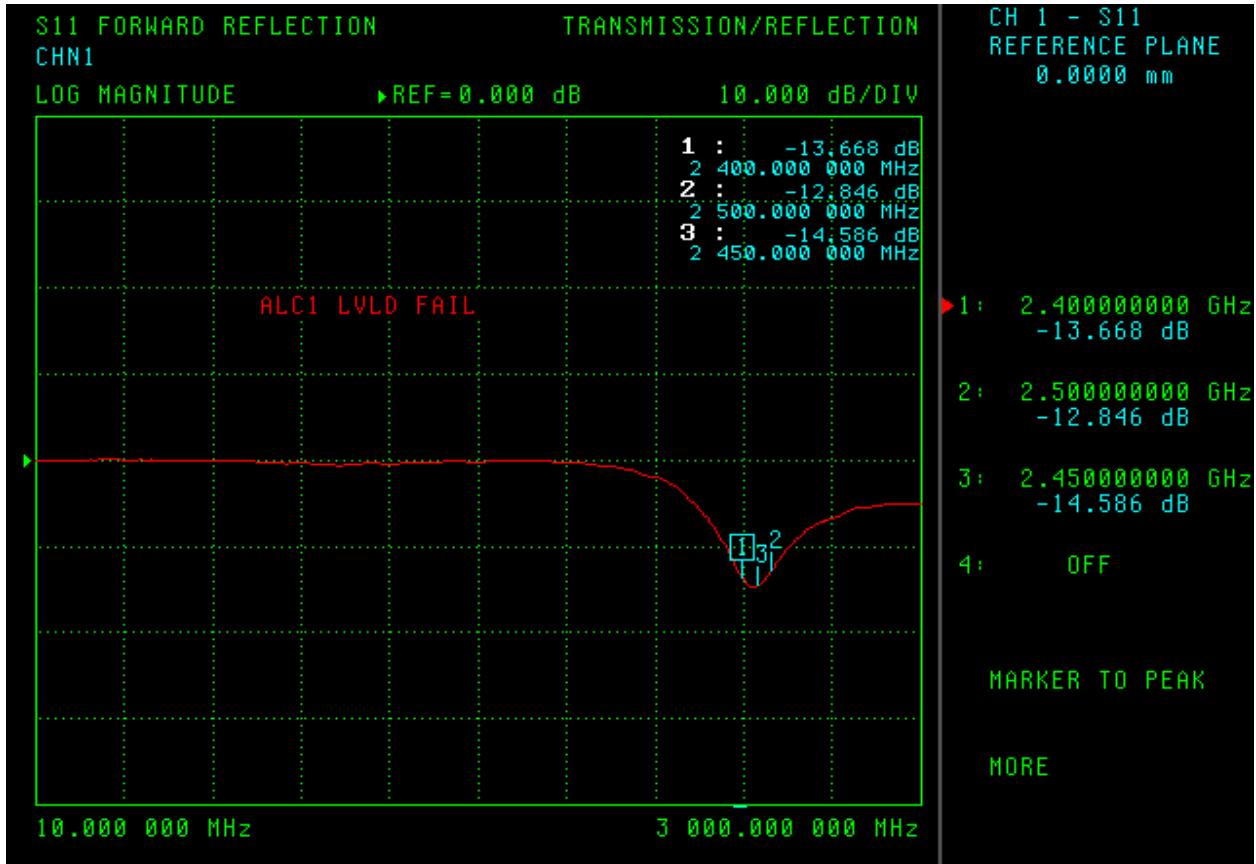

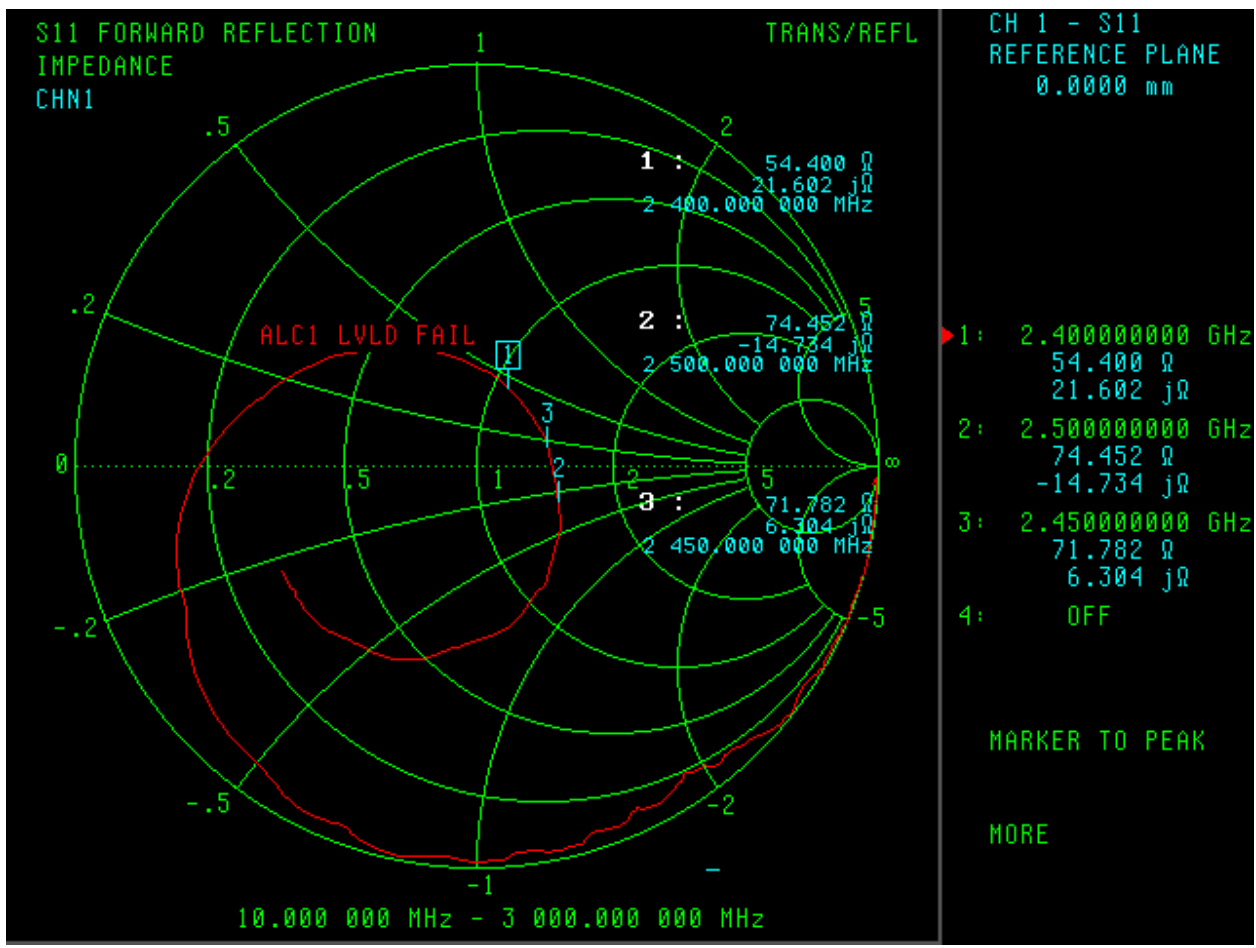

Far-field amplitude of TH240S E-Plane.nsi

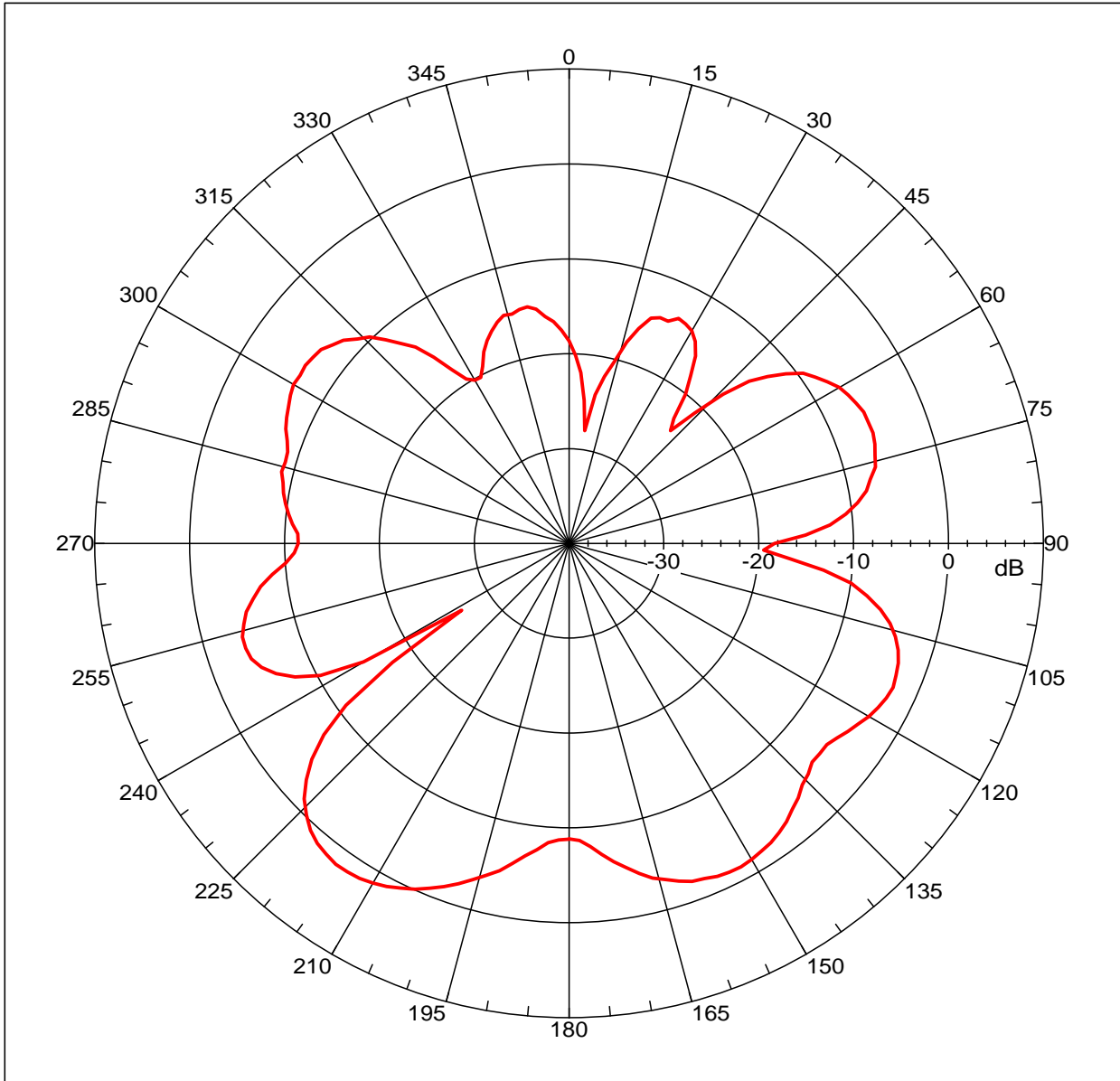

Far-field amplitude, Eprincipal: Linear, Tau = 0.000 deg
 Gain = 1.81285 dBi
 Max far-field (global) = -47.19478 dB, Max far-field (plot) = -47.19496 dB
 Normalization: Reference, Network offset = 0.000 dB
 Hpeak at: -144.000 deg, Vpeak at: 0.000 deg
 Plot centering: On

TH240S E-Plane

NSI2000 V4.0.124, Filename: C:\nsi2000\Midy\2.4G\TH240S E-Plane.nsi
 Measurement date/time: 9/3/2010 2:54:48 PM, Filetype: NSI-97

Far-field Cut Analysis:

Avg value: -7.098 dB
 -3. dB beam width: 25.21 deg
 -6. dB beam width: 36.40 deg
 -10. dB beam width: 48.37 deg
 Left Sidelobe: Not Found
 Right Sidelobe: -6.00 dB at -107.598 deg

Far-field display setup

Azimuth (deg)
 Span = 360.00001 deg, Center = 0.000 deg, #pts = 181
 Start = -180.00001 deg, Stop = 180.00001 deg, Delta = 2.000

deg

Elevation (deg)
 Center = 0.000 deg, #pts = 1

Selected beam(s) 1 of 3

Beam	Frequency	Azimuth	Elevation	Pol
1	2.400 GHz	Azimuth	Elevation	Single-pol

Far-field amplitude of TH240S E-Plane.nsi

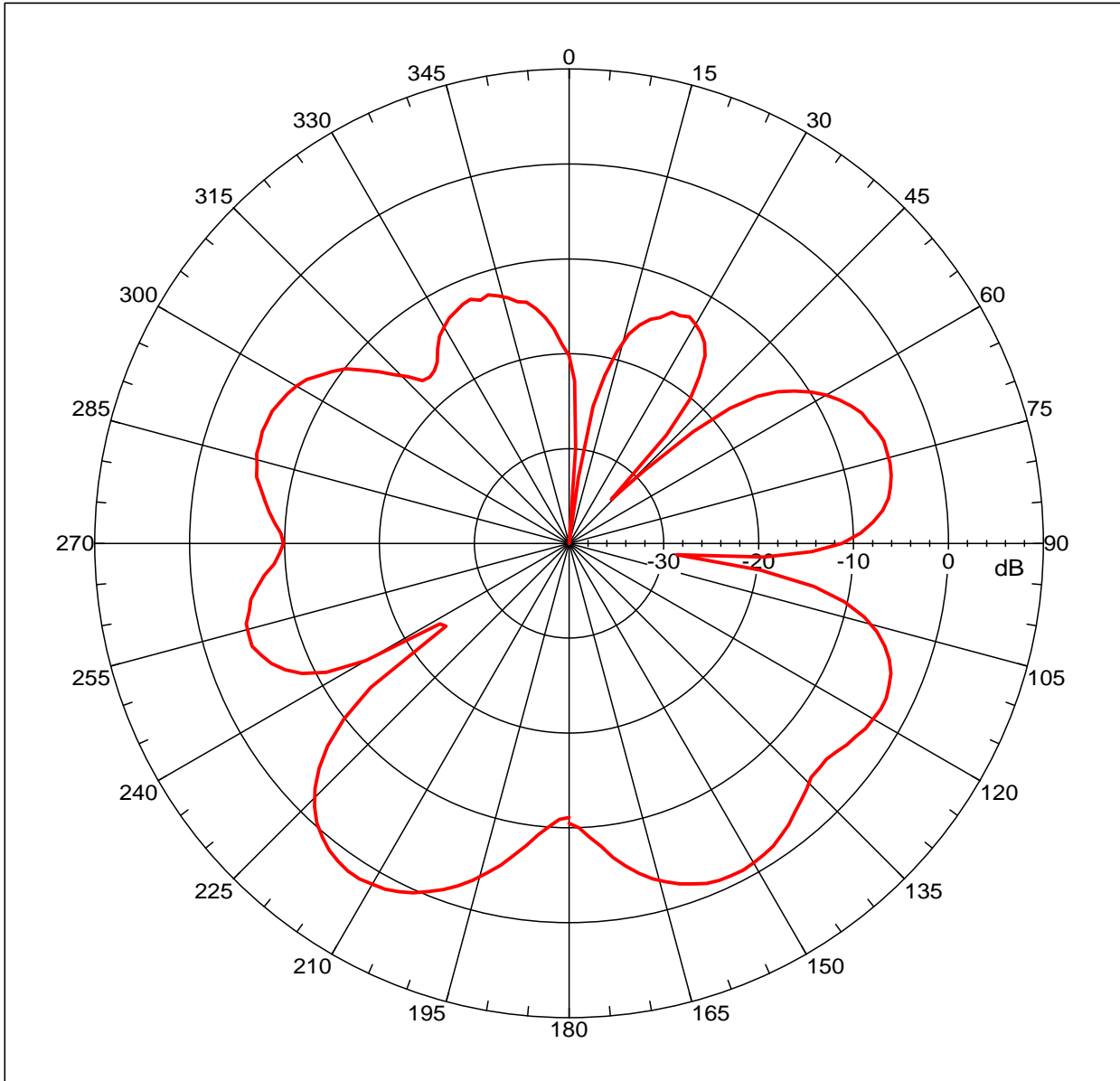

Far-field amplitude, Eprincipal: Linear, Tau = 0.000 deg
 Gain = 1.69501 dBi
 Max far-field (global) = -48.28314 dB, Max far-field (plot) = -48.28316 dB
 Normalization: Reference, Network offset = 0.000 dB
 Hpeak at: -148.00001 deg, Vpeak at: 0.000 deg
 Plot centering: On

TH240S E-Plane

NSI2000 V4.0.124, Filename: C:\nsi2000\Midy\2.4G\TH240S E-Plane.nsi
 Measurement date/time: 9/3/2010 2:54:48 PM, Filetype: NSI-97

Far-field Cut Analysis:

Avg value: -7.146 dB
 -3. dB beam width: 24.32 deg
 -6. dB beam width: 34.14 deg
 -10. dB beam width: 43.94 deg
 Left Sidelobe: Not Found
 Right Sidelobe: -6.57 dB at -107.598 deg

Far-field display setup

Azimuth (deg)
 Span = 360.00001 deg, Center = 0.000 deg, #pts = 181
 Start = -180.00001 deg, Stop = 180.00001 deg, Delta = 2.000 deg

Elevation (deg)
 Center = 0.000 deg, #pts = 1

Selected beam(s) 1 of 3

Beam	Frequency	Azimuth	Elevation	Pol
2	2.450 GHz	Azimuth	Elevation	Single-pol

Far-field amplitude of TH240S E-Plane.nsi

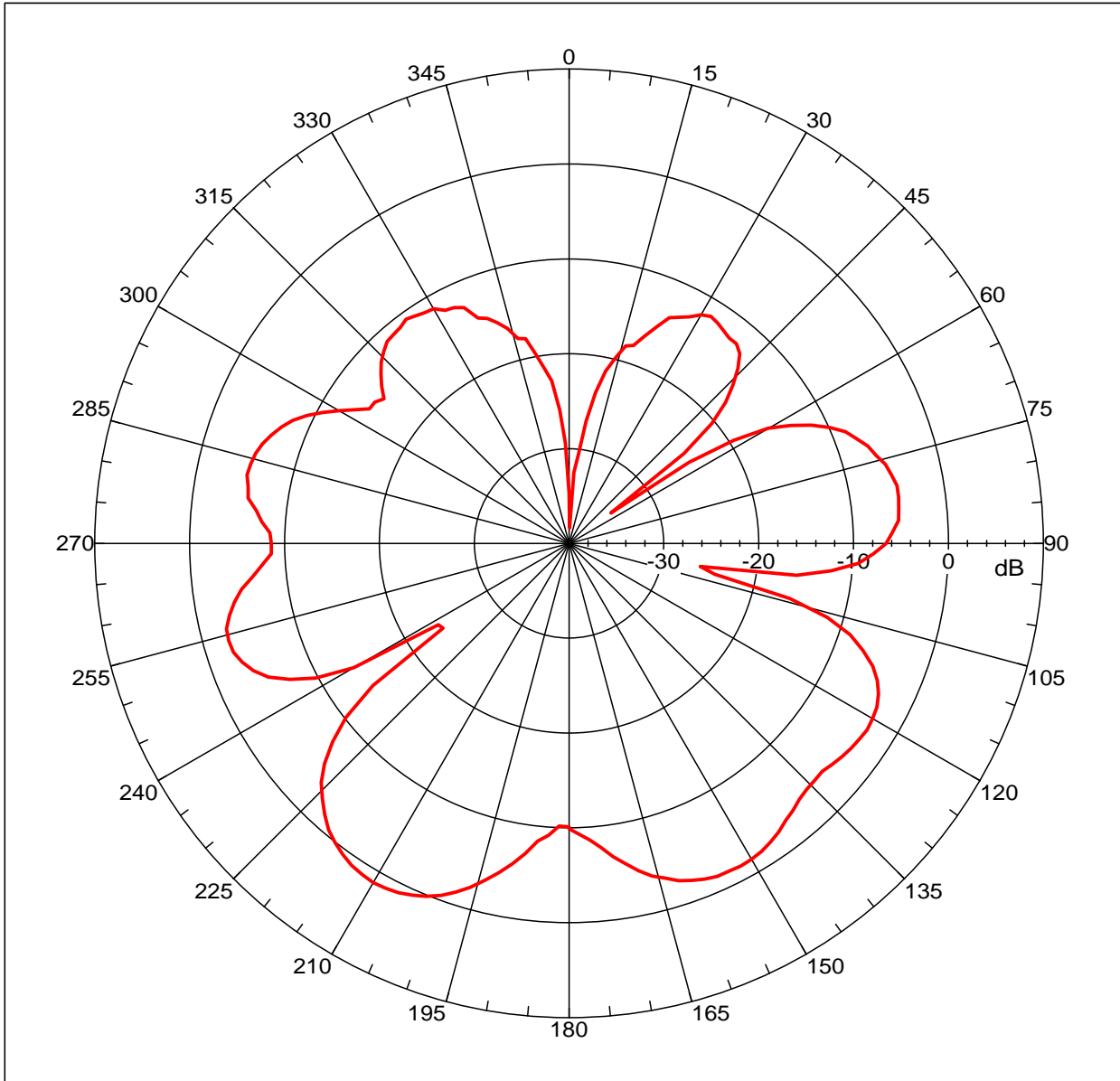

Far-field amplitude, Eprincipal: Linear, Tau = 0.000 deg
 Gain = 1.29147 dBi
 Max far-field (global) = -48.84452 dB, Max far-field (plot) = -48.84462 dB
 Normalization: Reference, Network offset = 0.000 dB
 Hpeak at: -150.00001 deg, Vpeak at: 0.000 deg
 Plot centering: On

TH240S E-Plane

NSI2000 V4.0.124, Filename: C:\nsi2000\Midy\2.4G\TH240S E-Plane.nsi
 Measurement date/time: 9/3/2010 2:54:48 PM, Filetype: NSI-97

Far-field Cut Analysis:

Avg value: -7.321 dB
 -3. dB beam width: 25.28 deg
 -6. dB beam width: 35.76 deg
 -10. dB beam width: 45.87 deg
 Left Sidelobe: Not Found
 Right Sidelobe: -3.99 dB at -105.587 deg

Far-field display setup

Azimuth (deg)
 Span = 360.00001 deg, Center = 0.000 deg, #pts = 181
 Start = -180.00001 deg, Stop = 180.00001 deg, Delta = 2.000

deg

Elevation (deg)
 Center = 0.000 deg, #pts = 1

Selected beam(s) 1 of 3

Beam	Frequency	Azimuth	Elevation	Pol
3	2.500 GHz	Azimuth	Elevation	Single-pol

Far-field amplitude of TH240S H-Plane.nsi

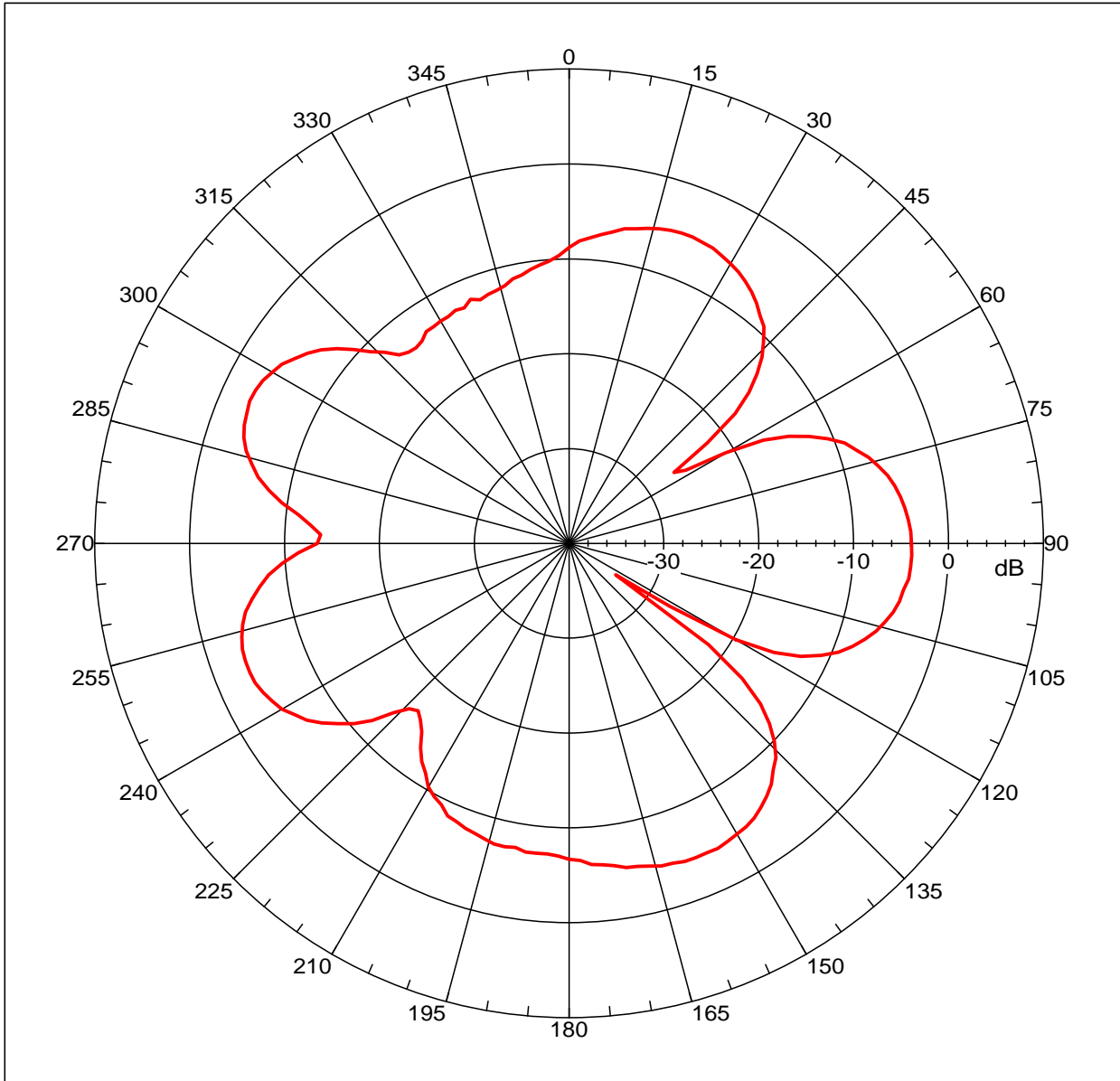

Far-field amplitude, Eprincipal: Linear, Tau = 0.000 deg
 Gain = -3.15714 dBi
 Max far-field (global) = -52.16477 dB, Max far-field (plot) = -52.1648 dB
 Normalization: Reference, Network offset = 0.000 dB
 Hpeak at: -66.00001 deg, Vpeak at: 0.000 deg
 Plot centering: On

TH240S H-Plane

NSI2000 V4.0.124, Filename: C:\nsi2000\Midy\2.4G\TH240S H-Plane.nsi
 Measurement date/time: 9/3/2010 3:01:50 PM, Filetype: NSI-97

Far-field Cut Analysis:

Avg value: -7.876 dB
 -3. dB beam width: 23.88 deg
 -6. dB beam width: 33.35 deg
 -10. dB beam width: 44.86 deg
 Left Sidelobe: -0.56 dB at -111.620 deg
 Right Sidelobe: -9.53 dB at -25.140 deg

Far-field display setup

Azimuth (deg)
 Span = 360.00001 deg, Center = 0.000 deg, #pts = 181
 Start = -180.00001 deg, Stop = 180.00001 deg, Delta = 2.000

deg

Elevation (deg)
 Center = 0.000 deg, #pts = 1

Selected beam(s) 1 of 3

Beam	Frequency	Azimuth	Elevation	Pol
1	2.400 GHz	Azimuth	Elevation	Single-pol

Far-field amplitude of TH240S H-Plane.nsi

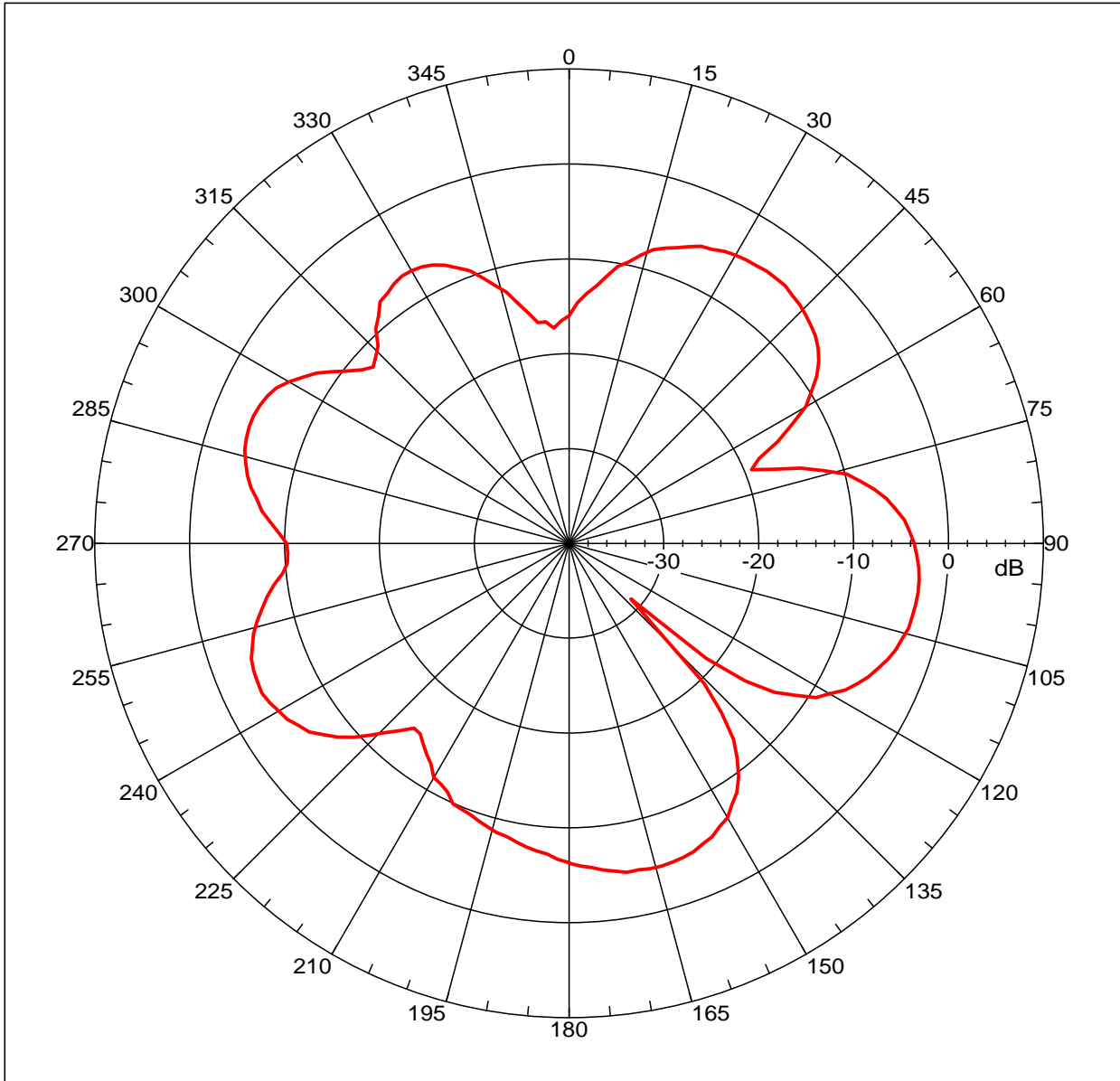

Far-field amplitude, Eprincipal: Linear, Tau = 0.000 deg
 Gain = -2.83735 dBi
 Max far-field (global) = -52.8155 dB, Max far-field (plot) =
 -52.81555 dB
 Normalization: Reference, Network offset = 0.000 dB
 Hpeak at: 97.99999 deg, Vpeak at: 0.000 deg
 Plot centering: On

TH240S H-Plane

NSI2000 V4.0.124, Filename: C:\nsi2000\Midy\2.4G\TH240S H-Plane.nsi
 Measurement date/time: 9/3/2010 3:01:50 PM, Filetype: NSI-97

Far-field Cut Analysis:

Avg value: -7.671 dB
 -3. dB beam width: 32.27 deg
 -6. dB beam width: 43.74 deg
 -10. dB beam width: 52.47 deg
 Left Sidelobe: -1.70 dB at 37.207 deg
 Right Sidelobe: -1.76 dB at 165.922 deg

Far-field display setup

Azimuth (deg)

Span = 360.00001 deg, Center = 0.000 deg, #pts = 181
 Start = -180.00001 deg, Stop = 180.00001 deg, Delta = 2.000

deg

Elevation (deg)

Center = 0.000 deg, #pts = 1

Selected beam(s) 1 of 3

Beam	Frequency	Azimuth	Elevation	Pol
2	2.450 GHz	Azimuth	Elevation	Single-pol

Far-field amplitude of TH240S H-Plane.nsi

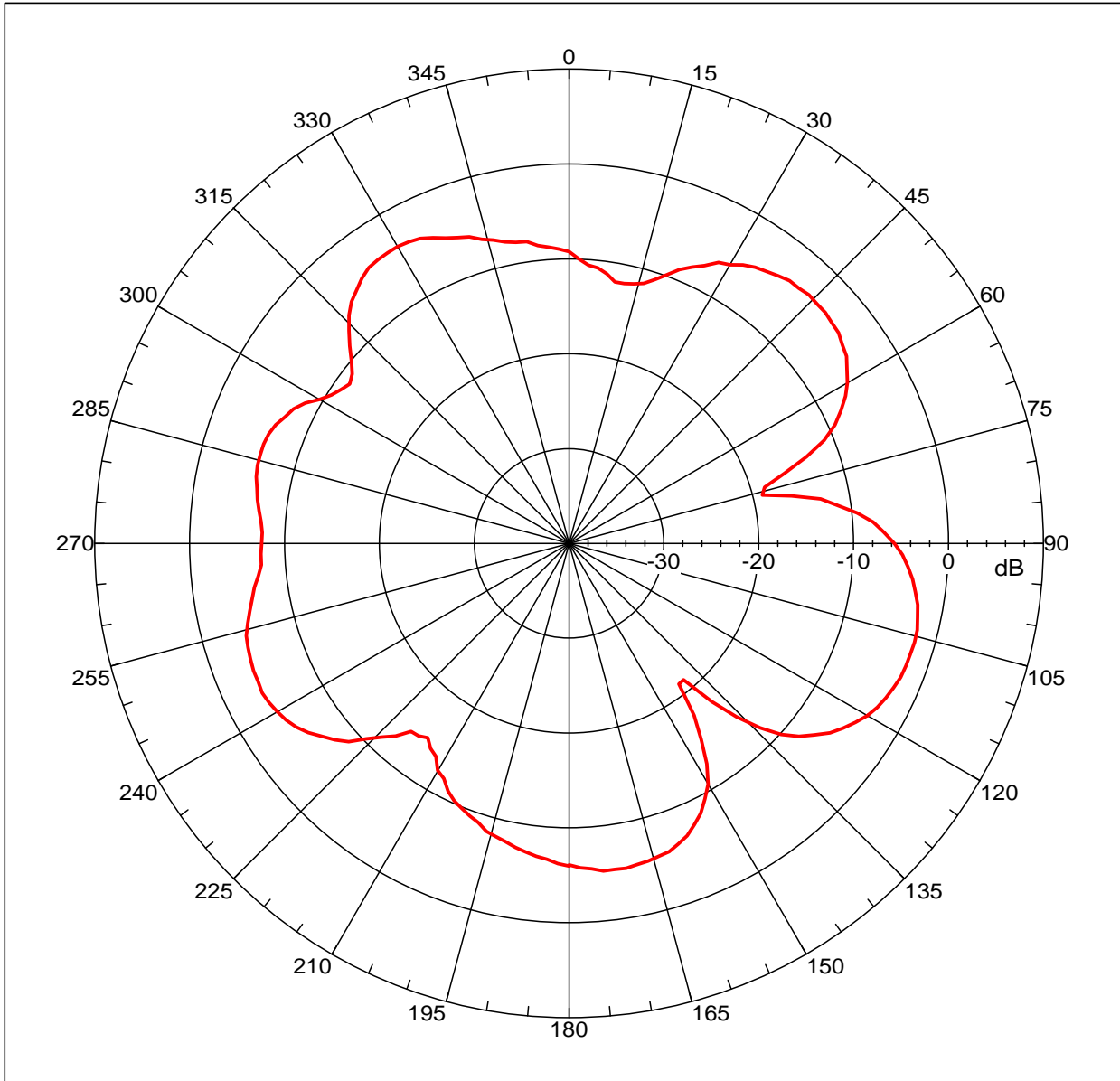

Far-field amplitude, Eprincipal: Linear, Tau = 0.000 deg
 Gain = -2.12931 dBi
 Max far-field (global) = -52.2653 dB, Max far-field (plot) =
 -52.26535 dB
 Normalization: Reference, Network offset = 0.000 dB
 Hpeak at: 105.99999 deg, Vpeak at: 0.000 deg
 Plot centering: On

TH240S H-Plane

NSI2000 V4.0.124, Filename: C:\nsi2000\Midy\2.4G\TH240S H-Plane.nsi
 Measurement date/time: 9/3/2010 3:01:50 PM, Filetype: NSI-97

Far-field Cut Analysis:

Avg value: -7.023 dB
 -3. dB beam width: 32.79 deg
 -6. dB beam width: 44.19 deg
 -10. dB beam width: 53.27 deg
 Left Sidelobe: -1.52 dB at 49.274 deg
 Right Sidelobe: -3.09 dB at 171.955 deg

Far-field display setup

Azimuth (deg)

Span = 360.00001 deg, Center = 0.000 deg, #pts = 181
 Start = -180.00001 deg, Stop = 180.00001 deg, Delta = 2.000

deg

Elevation (deg)

Center = 0.000 deg, #pts = 1

Selected beam(s) 1 of 3

Beam	Frequency	Azimuth	Elevation	Pol
3	2.500 GHz	Azimuth	Elevation	Single-pol